



Volvo Construction Equipment

ECR50D

VOLVO EXCAVATORS 5.0t 41.8hp



Big on power.

The ECR50D is a powerful 5-ton compact short swing radius excavator designed to deliver superior digging performance, high lifting capabilities and leading breakout and tear out forces. This machine is equipped to work on a range of jobs from utilities to site preparation, construction and landscaping. Reach further, dig deeper, load higher with the ECR50D.

Digging equipment

Experience an increased working range from new digging equipment together with an enhanced boom and attachment geometry. With its 5-ton weight, this machine effectively handles heavy loads with greater stability, balance and control.

Automatic two-speed travel

Tractive force has improved. For optimized travel speed and traction, the automatic two-speed travel function allows the operator to continually drive the machine at high speed. When more force is needed, speed is automatically reduced.



Float blade

Pushing up and forward on the blade lever engages the blade cylinder to exert a minimal but consistent amount of blade down force. The float blade, thanks to its ideally rounded design, provides precision finishing and is ideal for ground levelling, grading and contouring.

Digging forces

The ECR50D boasts superior breakout and tear out forces, as well as great lifting capacities – delivering fast cycle times in tough applications.



Engine and hydraulics

The Volvo hydraulic system is perfectly matched to the premium Volvo engine and components – delivering high performance and superior fuel efficiency. The state-of-the-art hydraulic system delivers fast response and smooth operation.



Volvo cab

The industry-leading Volvo cab boasts all-around visibility from large expanses of glass, ergonomically positioned controls and switches and excellent vibration and noise insulation. With superior leg and headroom, the operator will feel comfortable and productive in this spacious and safe environment. The Volvo cab is certified FOPS1 on top, TOPS and ROPS.

Built in comfort.

It's a fact that a comfortable operator environment naturally delivers higher productivity. That's why Volvo's industry-leading cab provides a spacious and safe work place with all-around visibility, an adjustable seat, ergonomically positioned controls and an efficient heating system. Control in comfort with Volvo.

Suspended seat and console

The seat and consoles are mounted on the same suspension and therefore move together – providing excellent shock and vibration absorption for maximum comfort. The multi-adjustable seat with ergonomic armrests includes a height alteration function.

Slew and offset movement

Simultaneous, boom offset movement and fingertip control of the slew delivers easy and fast machine positioning with outstanding control and comfort. Slewing is controlled by the left-hand lever while offset movement by an electro-proportional roller on the right-hand lever.



Cab access

The wide opening door, anti-slip step and three-point safety grip system ensure easy cab access. To further increase operator comfort when entering or exiting the cab, the console tilts backwards.

Anti-theft system (option)

To reduce the risk of theft, a code must be entered through the keypad to start the machine. It can be changed or disabled via the machine management system.

Superior serviceability.

At Volvo, we want you to get the most out of your machine. That's why we've made maintenance simple and built market-leading serviceability in to the ECR50D. All service check points are centralized and easily accessible from ground level – allowing you to spend more time working and earning. Maximize your uptime with Volvo.

Greasing points

Spend more time working and less time carrying out service tasks with grease points located on the same side of the machine and a 50 hour minimum greasing interval for all greasing points.

Engine access

The side position of the engine allows easy access to grouped check points including the engine oil, air filter, coolant level and fuel filtration check. The engine oil and engine filter service interval is up to 500 hours.



Patented hydraulic filter

With Volvo's patented, multifunctional hydraulic oil filter, filtration occurs when the tank is filled or topped up and before the oil returns via the drain lines. The transparent bowl enables easy oil level checks and permits early detection of contamination – allowing preventative maintenance to be carried out before damage occurs.



Service access

The side position of the engine, together with the two gas-strut-assisted and wide-opening hoods, ensures safe and easy access to all components and service check points from ground level. Grouped filters make maintenance simple and maximize uptime.



ECO mode

By simply pressing a button, Volvo's unique ECO mode reduces fuel consumption by up to 10% without any loss of performance in most operating conditions.

Optimized efficiency.

With state-of-the-art technology including Volvo's unique ECO mode and load-sensing hydraulics, the ECR50D delivers low fuel consumption with high digging power and fast cycle times. Reduce your fuel consumption and reach new levels of efficiency with Volvo.

Automatic engine shutdown

The auto engine shutdown function automatically turns the engine off to reduce fuel consumption and engine operating hours when the machine is inactive for a user-selected amount of time.



Auto-idle

Engine speed is reduced to idle when the controls are inactive for a user-selected amount of time or when the left-hand console is raised – reducing fuel consumption and noise. The engine instantly returns to the pre-selected speed when the operator touches any control.

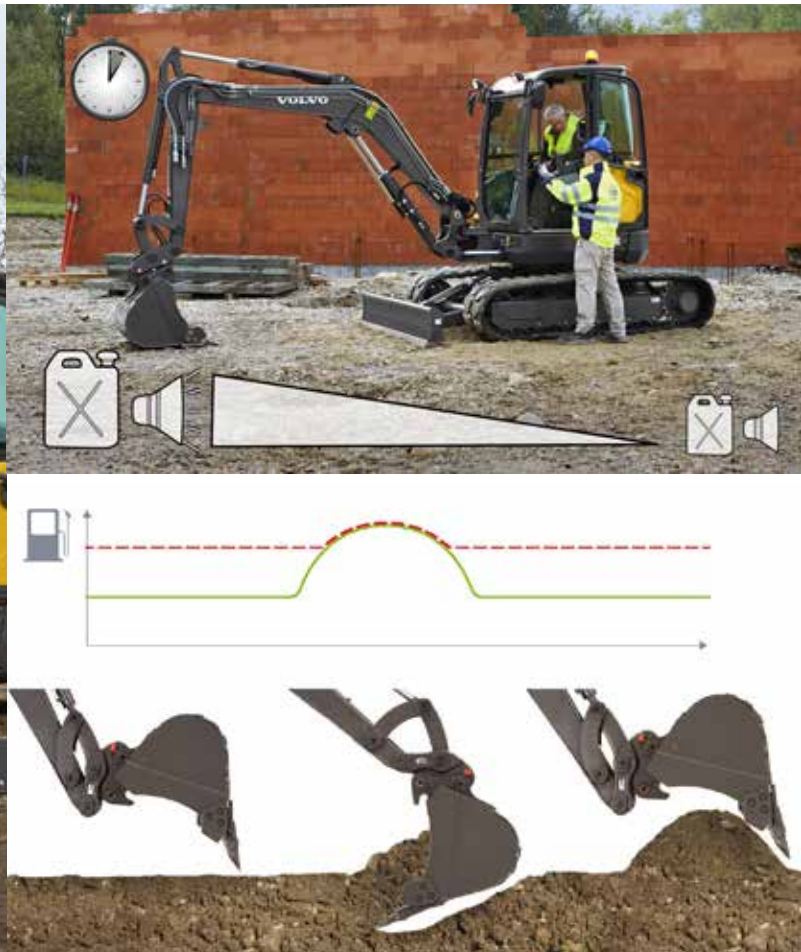

Load-sensing hydraulics

Volvo's load-sensing hydraulics supply power on demand, lowering fuel consumption. The system ensures fast response for quick cycle times while delivering smooth operation through precise control of the equipment.

A powerful 5-ton excavator.



Volvo cab

The industry-leading, spacious Volvo FOPS1 on top, TOPS and ROPS cab boasts all-around visibility, ergonomically positioned controls and excellent vibration and noise insulation.

Suspended seat and console

The multi-adjustable seat and console are mounted on the same suspension and therefore move together – providing excellent shock and vibration absorption.



Service access

The side position of the engine together with two, wide-opening hoods ensures safe and easy access to all components and service check points from ground level.



ECO mode

By simply pressing a button, Volvo's unique ECO mode reduces fuel consumption by up to 10%.

Patented hydraulic filter

Filtration occurs when the tank is filled or topped up and before the oil returns via the drain lines. The transparent bowl enables easy oil level and contamination checks.

Anti-theft system

To reduce the risk of theft, a code can be entered through the keypad to start the machine. It can be changed via the machine management system.



Automatic engine shutdown

This function automatically turns the engine off to reduce fuel consumption and cut engine operating hours when the machine is inactive for a pre-set amount of time.



Built ready

In combination with Volvo's durable range of attachments, the ECR50D allows you to easily switch between attachments, increasing your versatility and profitability.

Keypad

The keypad can be used to manage attachments through four pre-programmed, settings which can be customized to match individual needs.



Engine and hydraulics

The state-of-the-art, load-sensing hydraulic system is perfectly matched to the premium Volvo engine and components – delivering high performance and superior fuel efficiency.



Attachments

Volvo's durable attachments have been purpose-built to deliver maximum productivity and long service life in combination with Volvo machines.

Greasing points

To make maintenance easy, greasing points are located on the same side of the machine and the greasing interval is 50 hours.



Built ready.

In combination with Volvo's durable range of attachments, the ECR50D allows you to access more applications and effectively perform a variety of jobs – increasing your profitability. Easily switch between attachments and increase your versatility. Get the most out of your excavator with Volvo.

Keypad

Easily adjust the auxiliary hydraulic flows from inside the cab via the keypad controls and benefit from the correct speed and power for optimal attachment operation. The keypad has four pre-programmed, adjustable settings which can be customized to match attachment and individual needs. Flows can be independently changed in each direction.

Adjustable auxiliary flows (Breaker/Shear X1)

For ease of use, a gauge on the display clearly indicates the auxiliary settings.



Proportional hydraulic control on accessory circuits

With fingertip roller control and no auxiliary floor pedals, the operator can easily adjust the direction and amount of hydraulic flow. Benefit from the correct speed and power for your attachment as well as increased foot space.

High flow

The main auxiliary hydraulic circuit can deliver up to 75 litres of oil per minute, permitting the use of more demanding attachments.

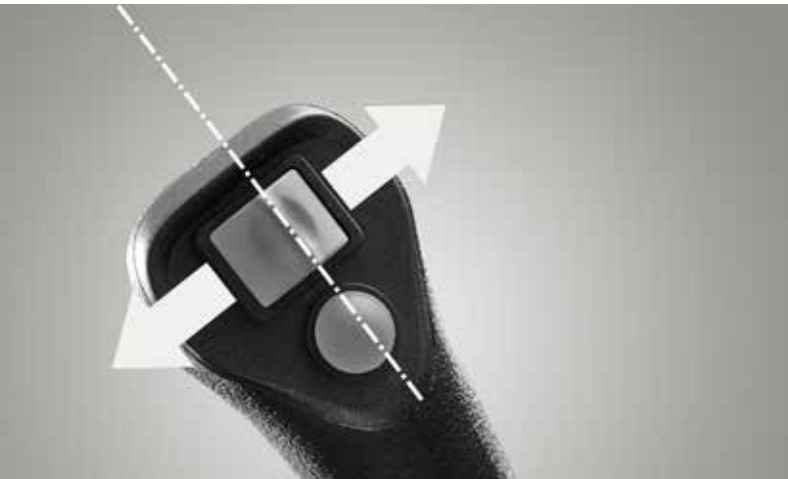

Quick coupler switch

By simply pressing the hydraulic quick coupler switch, the operator can easily change tasks and swap attachments without leaving the cab. This quick and efficient system increases versatility and productivity while also meeting the latest safety regulations.

Breaker toggle switch

For convenient and comfortable control, the operator can send maximum flow to the attachment by pressing a button on the joystick.



Matched attachments

Volvo's durable attachments have been purpose-built to work in perfect harmony with Volvo machines, forming one solid, reliable unit. With functions and properties ideally matched, Volvo attachments are an integrated part of the compact excavator for which they're intended.

The perfect match.

Volvo's durable attachments have been purpose-built as an integrated part of the excavator for which they're intended – forming one solid, reliable unit and delivering maximum productivity. With functions and properties ideally matched, you'll experience faster cycle times and excellent control.

Interfaces

Volvo's dedicated quick couplers pick up Volvo Attachments, including breakers, thumbs and buckets for use in both the face shovel and normal position.

Volvo mechanical quick coupler

Volvo hydraulic quick coupler



Bucket transport system

Volvo's simple and effective bucket transportation system enables a ditching bucket to safely carry general purpose buckets. Transportation hooks help to secure attachments against the blade at the end of the working day.



Buckets

General purpose buckets

The perfect tool for trenching and handling in a variety of soil conditions. Available in different widths.



Volvo hydraulic thumb

Designed to work with both Volvo direct fit buckets and with quick coupler in various materials. Used for piling, placing, loading, lifting and carrying.



Fixed ditching buckets

Ideal for ditch cleaning, grading, landscaping and backfilling.

- Round-shaped body
- Central reinforcing plates gives added strength and rigidity
- Drainage holes to reduce weight during operation



Tiltable ditching bucket

This bucket can be tilted 45° to each side making it a flexible and versatile solution for grading, landscaping, ditch cleaning and backfilling. Buckets are delivered "ready to work", with:

- Two hydraulic hoses.
- Two hydraulic connectors (Flat faces).
- One Volvo operator manual.



Volvo Tooth System and wear parts



General purpose



Pick point



Side cutter



Twin pick



Spade nose

Side cutters ensure longer bucket life by protecting the side plates and corner welds.

Hydraulic Breaker

Volvo's durable hydraulic breakers have been designed for ultimate compatibility with Volvo excavators. The range has been built to break the most demanding materials and combines excellent performance with low noise and vibration levels.



Volvo ECR50D in detail.

Engine		
Engine EU Stage 3A	Volvo	D2.6A
Rated speed	r/s / r/min	36.6 / 2 200
Maximum Gross power, ISO 3046-1	kW / hp	31.2 / 41.8
Max torque at	Nm / r/min	155 / 1 300
Nb of cylinders		4
Displacement	l	2.615
Bore	mm	87
Stroke	mm	110
Compression ratio		19
Electrical system		
Rated voltage	V	12
Battery capacity	Ah	74
Alternator	V / A	12 / 70
Hydraulic system		
Maximum system flow	l/min	103
Maximum flow for accessories	l/min	75
Maximum pressure for accessories	MPa/bar	22 / 220
Maximum flow for 2nd accessory circuit (option)	l/min	23
Maximum operating pressure	MPa/bar	26 / 260
Digging performances		
Standard bucket width (blade, W/O side cutter)	mm	600
Standard bucket mass	kg	113
Standard bucket rated capacity	m ³	0.144
Bucket rotation	deg	200
Bucket ISO breakout force	daN	3 612
Short arm (1400mm) ISO tearout force	daN	2 593
Long arm (1800mm) ISO tearout force	daN	2 177
Swing system		
Max, slew speed	r/min	9.5
Max, slew torque	daN.m	1 400
Undercarriage		
Rubber track width	mm	400
Bottom / Top rollers per side		5 / 1
Track tension		by grease piston
Blade (width x height)	mm	1 920 x 351

Drive		
Max, drawbar pull	daN	3 450
Max. travel speed (low / high)	km/h	3.0 / 4.9
Gradeability	deg	30
Service refill capacities		
Fuel tank	l	64.5
Hydraulic system, total	l	62
Hydraulic tank	l	32
Engine oil	l	10.2
Engine coolant	l	9.8
Travel reduction unit	l	2 X 1
Sound Level		
Interior sound level according to ISO 6396 (LpA)	dB(A)	78
External sound level according to ISO 6395 and EU Noise Directive (2000/14/EC) and 474-1:2006 +A1:2009 (LwA)	dB(A)	96
Weight and ground pressure		
Operating weight according to ISO 6016 (according to most usual configuration and including 75kg operator)	kg	5 010
Ground pressure	kg/cm ² (kPa)	0.29 (28.4)
Transport weight (Heated cab, 380mm rubber tracks, short arm, 600mm direct-fit bucket, full fuel tank)	kg	4 935
With thumb	kg	+65
With extra counterweight	kg	+170
With long arm and additional counterweight	kg	+195
With 380mm steel tracks	kg	+100

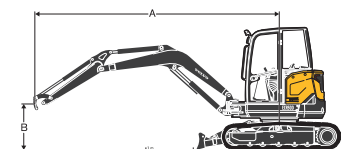

LIFTING CAPACITY ECR50D

These capacities are given for a machine equipped with a cabin, 400mm rubber tracks and without a bucket or quick-coupler. The below values are in compliance with ISO standard 10567. They do not exceed 75% of the tipping load or 87% of the hydraulic limit with the machine on firm level ground. Loads marked with an asterisk (*) are limited by machine's hydraulic lifting capacity rather than tipping load. Caution: In accordance with standard EN 474-5, the machine must be equipped to carry out handling operations. It is the operator's obligation to know and follow the applicable national and local safety regulations.

	Lifting point height (B) m	2.0 m		3.0 m		4.0 m		Max. reach		Max. m	
Arm: 1 400mm + Dozer blade up	3	kg				892	770	700	605	4.65	
	2	kg			1 332	1 129	866	745	615	5.01	
	1	kg			1 250	1 052	833	713	589	5.09	
	0	kg			1 217	1 021	811	692	610	4.93	
	-1	kg	2 404	1 922	1 217	1 021	808	689	696	597	4.48
Arm: 1 800mm + Additional counterweight + Dozer blade up	-2	kg	2 449	1 962	1 244	1 046			961	819	3.6
	3	kg					877*	839	764	672	5.07
	2	kg			1 318	1 241	1 076	810	689	512	5.39
	1	kg			1 569	1 150	1 041	772	572	589	5.48
	0	kg	968*	968*	1 514	1 098	1 011	744	684	504	5.33
Arm: 1 400mm Dozer blade down	-1	kg	2 030*	2 030*	1 502	1 087	999	733	760	560	4.92
	-2	kg	2 977	2 067	1 519	1 102	1 012	745	962	710	4.16
	3	kg					1 048*	770	1 077*	605	4.65
	2	kg			1 634*	1 129	1 227*	745	1 100*	531	5.01
	1	kg			2 253*	1 052	1 456*	713	1 139*	508	5.09
Arm: 1 800mm + Additional counterweight + Dozer blade down	0	kg			2 450*	1 021	1 589*	692	1 189*	597	4.93
	-1	kg	2 460*	1 922	2 293*	1 021	1 522*	689	1 238*	597	4.48
	-2	kg	2 841*	1 962	1 727*	1 046			1 241*	819	3.6
	3	kg					877*	839	863*	672	5.07
	2	kg			1 318*	1 241	1 076*	810	866*	512	5.39
Arm: 1 800mm + Additional counterweight + Dozer blade down	1	kg			2 014*	1 150	1 339*	772	908*	589	5.48
	0	kg	968*	968*	2 385*	1 098	1 533*	744	1 014*	504	5.33
	-1	kg	2 030*	2 030*	2 375*	1 087	1 559*	733	1 115*	560	4.92
	-2	kg	3 560*	2 067	2 011*	1 102	1 279*	745	1 161*	710	4.16

*hydraulic limit

Specifications.

DIMENSIONS ECR50D

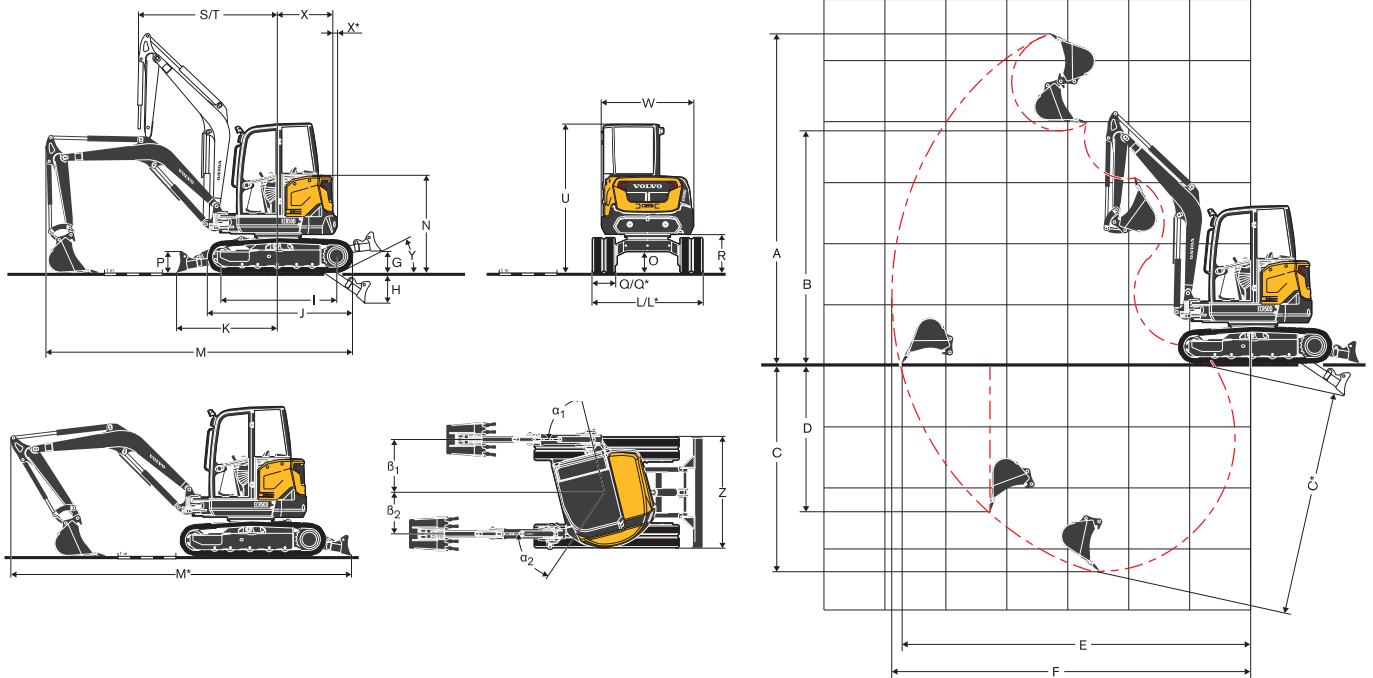

Description	Unit	Arm 1 400 mm	Arm 1 800 mm
A	Maximum cutting height	5 400	5 656
B	Maximum dump height	3 809	4 070
C	Digging depth	3 400	3 800
C*	Maximum digging depth	3 659	4 048
D	Maximum vertical wall digging depth	2 417	2 791
E	Maximum digging reach at ground level	5 771	6 161
F	Maximum digging reach	5 908	6 288
G	Highest position dozer blade		441
H	Lowest position dozer blade		580
I	Tumbler length		1 955
J	Track length		2 507
K	Dozer blade, maximum reach at ground level		1 748
L	Overall width with 400mm rubber tracks		1 920
L*	Overall width with 380mm steel tracks		1 900
M	Overall length	5 266	5 090
M*	Transport length	5 992	5 883
N	Overall height of engine hood		1 678
O	Minimum ground clearance		360
P	Dozer blade height		367
Q	Shoe width (rubber)		400
Q*	Shoe width (steel)		380
R	Ground clearance to superstructure		666
S	Front slew radius	2 450	2 495
T	Front slew radius with maximum offset	1 948	1 984
U	Overall height		2 570
W	Overall width of superstructure		1 603
X	Tail slew radius	960	1 033
X*	Additional counterweight overhang	73	(incl.)
Y	Angle of approach		30
Z	Dozer blade width		1 920
α_1	Maximum boom swing angle to the left		76
β_1	Maximum boom offset to the right		922
α_2	Maximum boom swing angle to the right		56
β_2	Maximum boom offset to the left		726

Equipment.

STANDARD EQUIPMENT

Engine

Low emission, direct injection, water-cooled, Volvo 4-cylinder diesel engine, meeting EU Stage 3A environmental regulations.

Engine restart prevention system. Starter motor is protected against ignition when engine is already running.

Auto engine shutdown. A maximum low idling time can be defined by operator. This function can be set, engaged and stopped easily through the keypad.

Dry-type single element air filter.

Plastic fuel tank with drain plug.

Water separator.

Translucent fuel filter.

Electric/Electronic control system

Maintenance free battery.

IP67 protected electrical system and high quality connectors.

Removable battery cut-off switch.

Two working lights on cab.

In-cab 12V power socket.

V-CADS pro

Hydraulic system

Variable displacement, load-sensing piston pump.

Closed centre flow-sharing main control valve.

Boom up

Arm out

Boom offset, both sides

Patented filtering and filling element.

Large tiltable oil cooler.

Double-acting hydraulic circuit for accessories up to arm end.

Hammer / shear valve.

Plastic tank with drain plug.

Swing system

Radial piston hydraulic motor with direct engagement on the ball internal crown wheel (no reduction gears).

Integrated shockless valve.

Automatic multi-disc slew brake.

Centralized and remote lubrication of crown wheel & ball bearing.

Drivetrain

Axial piston hydraulic motors equipped with an epicyclic reduction gears.

Automatic two speed travel

Bottom flanged rollers lubricated for life.

Grease tensioning wheel lubricated for life.

Undercarriage and dozer blade

"X" shape, box welded fabricated frame with sloping side members.

2 Tie-down points on the dozer blade.

2 Tie-down points on the frame.

2 Integrated lifting points.

Sturdy removeable protecting covers for track motors and slew system.

400HB weld-on edge on dozer blade

Digging Equipment

Monobloc box welded boom.

Boom cylinder rod protection.

Monobloc box welded arm.

Long-life steel bushings.

Hardened, pre-lubricated and corrosion resistant pins.

50 hours greasing intervals.

Single side greasing points

Cab

FOPS on top level 1 (Falling Object Protective Structure).

TOPS (Tip-Over Protective Structure).

ROPS (Roll-Over Protective Structure).

Cushioned operator station

Large door access.

Large and roomy uncluttered floor

Gas-strut assisted front window opening.

Front windscreen wiper and washer nozzle.

Right hand side sliding window.

Heating systems with in-cab adjustment of temperature and air flow level.

Multiple adjustable air vents.

Filtered air inlet.

Provision for a radio (antenna and electric wiring already fitted).

Cab inside light.

Seat-belt with warning indicator.

Right rear-view mirror.

Cupholder.

Net.

Machine controls

Proportional finger tip control for boom offset.

Proportional finger tip control for auxiliary circuit with flow adjustment

Direct access to main auxiliary settings (X1) via 3 function oriented buttons.

Possibility to individually adjust and register the flow settings.

Breaker toggle switch on right joystick

Digital engine control with direct access to ECO mode, auto-idle and two preset engine speed. Possibility to individually adjust and register the two preferred engine speed.

Access to machine management system through right display and intuitive keypad.

Automatic locking device for pilot controls and travel levers when the left console is raised.

Engine starting safety device: the left console must be raised to operate the starter.

Pressure accumulator to lower the equipment on the ground when the engine is switched off.

High torque / automatic two speed change over button on the keypad.

High speed toggle switch on the dozer blade lever.

Large travel pedals

Instrumentation and monitoring

Water temperature and fuel level gauges.

Warning lights for hydraulic filter and air filter restriction.

Self-acting emergency engine shutdown. Prevents failures in case of coolant overheating or too low engine oil pressure.

Several warning lights, coupled to an audible signal, in the event of malfunction (overheating, drop in oil pressure, low battery voltage...)

Official approval

Machine conforming to European directive 2006/42/EC.

Noise emissions in the environment conforming to directive 2000/14/EC.

Hand Arm Vibrations - Whole Body Vibrations compliant with directive 2002/44/EC.

Electromagnetic compatibility (EMC) conforming to European directive 2004/108/EC and its amendments.

Object handling device conforming to EN 474-1 and EN 474-5 standards.

FOPS on top level 1 conforming to ISO 10262 standard.

TOPS conforming to ISO 12117 and EN 13531 standards.

ROPS conforming to ISO 3471-1 and / SAE J1040 standards.

EQUIPMENT

- = Standard
- = Option

Operator environment

Cab with heater	◦
Cab with heater and air conditioning	◦
Vinyl seat, height adjustable, with mechanical suspension, extended-back seat and 2" retractable seat belt	◦
Fabric seat, height adjustable, with mechanical suspension, extended-back seat and 2" retractable seat belt	◦
Vinyl seat, with mechanical suspension, low back seat and 2" seat belt	◦
Storage box	•
Cab roof	◦
ISO / SAE control pattern change	◦
Travel alarm	◦
Radio, CD, MP3	◦
Anti-theft device	◦
Digital hourmeter	•
Extra hour meter (mechanical)	◦

Machine exterior

Right rearview mirror	•
Left rearview mirror	◦
Protected worklight on the boom	◦
Rotating beacon + rear worklight	◦
Additional counterweight	◦
Severe-duty guards for cab OPG2	◦
Several level of paint customisation (RAL specifications) to match with your corporate identity	◦

Digging equipment

Short arm	◦
Short arm + thumb bracket	◦
Long arm + additional counterweight	◦
Long arm + thumb bracket + additional counterweight	◦

Undercarriage equipment

400mm rubber tracks	◦
380mm steel tracks	◦

Hydraulic equipment

Proportional finger tip control for boom offset	•
Proportional finger tip control for accessories	•
Accessory flow adjustment	•
Two secondary relief valves for auxiliaries	•
Hydraulic drain for accessories	◦
Breaker and clamshell auxiliaries	◦
Second accessory circuit	◦
Kit 2 flat face hydraulic quick couplings	◦
Kit 4 flat face hydraulic quick couplings	◦
Single acting circuit for quick couplers	◦
Double acting circuit for quick couplers	◦
Boom & arm safety lifting valves with overload indicator	◦
Boom, arm and dozer blade safety lifting valves with overload indicator	◦
Float blade	•
Safety valve certification	◦
Mineral hydraulic oil VG46	◦
Bio hydraulic oil VG46 (PANOLIN®)	◦
Mineral hydraulic oil VG68	◦
Mineral hydraulic oil VG32	◦
Bio hydraulic oil VG32 (PANOLIN®)	◦

Engine

Dual stage air filter	◦
Engine auto idling with time adjustment	•
Engine auto shut-down with time adjustment	•

Service and maintenance

Tool kit	◦
----------	---

Telematics

Care Track	◦
------------	---

Attachments

Volvo quick coupler mechanical (pin-on)	◦
Volvo hydraulic quick coupler (pin-on)	◦
Lehnhoff® Quick Coupler Mechanical (MS03)	◦
S-type hydraulic quick coupler (S40)	◦
Thumb with short clamp (for direct fit bucket)	◦
Thumb with long clamp (when using quick coupler)	◦
General purpose buckets (300mm / 62L up to 900mm / 235L)	◦
Fix ditching buckets (1300mm / 190L and 1500mm / 221L)	◦
Tiltable ditching buckets (1300mm / 190L)	◦
Hydraulic breaker HB06LN	◦

Not all products are available in all markets. Under our policy of continuous improvement, we reserve the right to change specifications and design without prior notice. The illustrations do not necessarily show the standard version of the machine.

SELECTION OF VOLVO OPTIONAL EQUIPMENT



Long arm and extra counter-weight

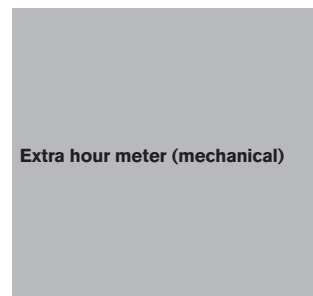

Extra hour meter (mechanical)

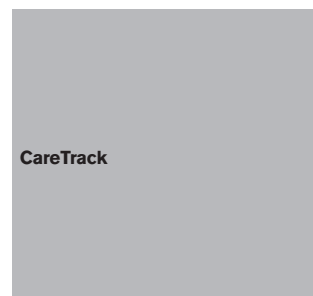

CareTrack

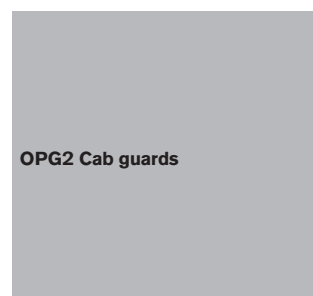

OPG2 Cab guards



Specific color machine

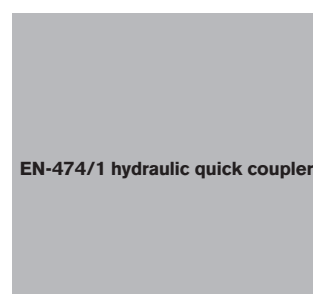

EN-474/1 hydraulic quick coupler



PES Plant Sales
Beare Works
Beare
Nr Exeter
EX5 3JX
01392 882220



VOLVO

Volvo Construction Equipment

www.volvoce.com